

ООО «КВАНТУМ»
633010, Новосибирская область,
г. Бердск, ул. Ленина, 89/8 офис 607

Для писем:
630090, г. Новосибирск, ул. Кутателадзе, зд. 4г , офис 218

Заместитель директора
Шурубор Игорь Израилович
Телефон: +79059370957
Email: shr030@yandex.ru

Web: www.opticsquantum.ru
Email: salequantum@yandex.ru



ООО КВАНТУМ

ОПТИЧЕСКИЕ КОМПОНЕНТЫ





Кодировка : EVC-1205

Технические характеристики: Ø11.5x5.4mm

Item: EVC-1205

Specification: Ø11.5x5.4mm

Кодировка : EVC-1916

Технические характеристики: Ø19x16mm

Item: EVC-1916

Specification: Ø19x16mm

Кодировка : EVC-2608

Технические характеристики: Ø26x8mm

Item: EVC-2608

Specification: Ø26x8mm

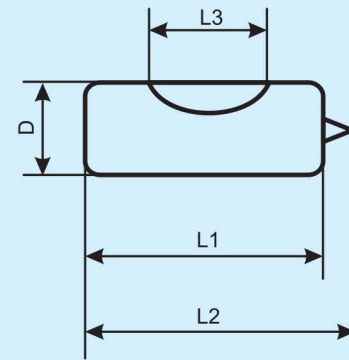

ITEM	D(mm)	L1(mm)	L2(mm)	L3(mm)	SENSITIVITY
EVT-01-1	8	18	21	8	5/2mm 9/2mm 10/2mm 12/2mm
EVT-01-2	8	18	21	9	
EVT-01-3	8	19	22	9.5	
EVT-01-4	8	20	23	9.5	
EVT-01-5	8	20	23	10	
EVT-01-6	8	20	23	10.5	
EVT-01-7	8	20	23	11	

Одноосный электрический датчик / Single-axis Photoelectric sensor

Размеры (Dimensions): 25*25*12.5mm

Чувствительность (Sensitivity) :

A: 10' K=13-17mv/1"

B: 9' K=12-16mv/1"

C: 12' K=9-12mv/1"

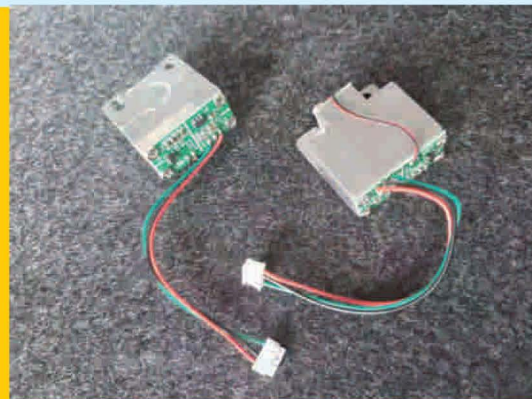

GLASS SIDESLIP M



TER FOR AIRCRAFT

GLASS SIDESLIP M



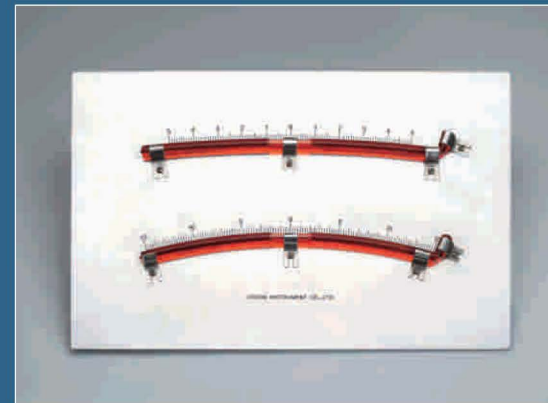

Кодировка : QJ-S372
 Технические характеристики : 372(L)x241(W)x3mm(T)
 Точность: верхний блистер 6 футов /2mm(1.8mm/m)
 Нижний блистер 15 футов /2mm(4.5mm/m)
 Диапазон измерения: $\pm 5^\circ/\pm 15^\circ$

Item: QJ-S372
 Spec: 372(L)x241(W)x3mm(T)
 Sensitivity: 6'/2mm(1.8mm/m) for top vial
 15'/2mm(4.5mm/m) for bottom vial
 Measuring range: $\pm 5^\circ/\pm 15^\circ$



Кодировка : QJ-S120
 Технические характеристики : 120(L)x50(W)x15mm(T)
 Точность: 30 футов /2mm(9mm/m)
 Диапазон измерения : $\pm 10^\circ$

Item: QJ-S120
 Spec: 120(L)x50(W)x15mm(T)
 Sensitivity: 30'/2mm(9mm/m)
 Measuring range: $\pm 10^\circ$



Кодировка : QJ-S110
 Технические характеристики : 110(L)x30(W)x10mm(T)
 Точность: 30 футов /2mm(9mm/m)
 Диапазон измерения : $\pm 9^\circ$

Item: QJ-S110
 Spec: 110(L)x30(W)x10mm(T)
 Sensitivity: 30'/2mm(9mm/m)
 Measuring range: $\pm 9^\circ$



Код : MC-15011520
 Точность : 5'/2mm
 Технические характеристики : $\varnothing 150 \times 115 \times 20 \text{mm}$

Item: MC-15011520
 Sensitivity: 5'/2mm
 Specification: $\varnothing 150 \times 115 \times 20 \text{mm}$



Код : MC-1007520
 Точность : 30'/2mm
 Технические характеристики : $\varnothing 100 \times 75 \times 20 \text{mm}$

Item: MC-1007520
 Sensitivity: 30'/2mm
 Specification: $\varnothing 100 \times 75 \times 20 \text{mm}$



Код : MC-907015
 Точность : 30'/2mm(9mm/m)
 Технические характеристики : $\varnothing 90 \times 70 \times 15 \text{mm}$

Item: MC-907015
 Sensitivity: 30'/2mm(9mm/m)
 Specification: $\varnothing 90 \times 70 \times 15 \text{mm}$



Код : MC-806015
 Точность : 60'/2mm(18mm/m)
 Технические характеристики : $\varnothing 80 \times 60 \times 15 \text{mm}$

Item: MC-806015
 Sensitivity: 60'/2mm(18mm/m)
 Specification: $\varnothing 80 \times 60 \times 15 \text{mm}$



Код : MC-803518
 Точность : 30'/2mm(9mm/m)
 Технические характеристики : $\varnothing 80 \times 35 \times 18 \text{mm}$

Item: MC-803518
 Sensitivity: 30'/2mm(9mm/m)
 Specification: $\varnothing 80 \times 35 \times 18 \text{mm}$



Код : MC-483513-1
 Точность : 5'/2mm(1.5mm/m)
 Технические характеристики : $\varnothing 48 \times 35 \times 13 \text{mm}$

Item: MC-483513-1
 Sensitivity: 5'/2mm(1.5mm/m)
 Specification: $\varnothing 48 \times 35 \times 13 \text{mm}$



Код : MC-483513-2
 Точность : 60'/2mm(18mm/m)
 Технические характеристики : $\varnothing 48 \times 35 \times 13 \text{mm}$

Item: MC-483513
 Sensitivity: 60'/2mm(18mm/m)
 Specification: $\varnothing 48 \times 35 \times 13 \text{mm}$



Код : MC-1007520-SL
 Точность : 30'/2mm(9mm/m)
 Технические характеристики : $\varnothing 100 \times 75 \times 20 \text{mm}$

Item: MC-1007520-SL
 Sensitivity: 30'/2mm(9mm/m)
 Specification: $\varnothing 100 \times 75 \times 20 \text{mm}$



Код : MC-6012
 Точность : 15'/2mm(4.5mm/m)
 Технические характеристики : $\varnothing 60 \times 12 \text{mm}$



Item: MC-6012
 Sensitivity: 15'/2mm(4.5mm/m)
 Specification: $\varnothing 60 \times 12 \text{mm}$



Код : MC-3010
 Точность : 90'/2mm(27mm/m)
 Технические характеристики : $\varnothing 30 \times 10 \text{mm}$

Item: MC-3010
 Sensitivity: 90'/2mm(27mm/m)
 Specification: $\varnothing 30 \times 10 \text{mm}$

Metal spirit levels

 <p>Код : MC-312010 Точность: 30'/2mm(9mm/m) Технические характеристики: Ø31x20x10mm</p> <p>Item: MC-312010 Sensitivity: 30'/2mm(9mm/m) Specification: Ø31x20x10mm</p>	 <p>Код : MC-231595 Точность: 15'/2mm(4.5mm/m) Технические характеристики: Ø22.8x15x9.5mm</p> <p>Item: MC-231595 Sensitivity: 15'/2mm(4.5mm/m) Specification: Ø22.8x15x9.5mm</p>
---	--

 <p>Код : MC-291708 Точность: 6'/2mm(1.8mm/m) Технические характеристики: Ø28.6x17x8mm</p> <p>Item: MC-291708 Sensitivity: 6'/2mm(1.8mm/m) Specification: Ø28.6x17x8mm</p>	 <p>Код : MC-432713 Точность: 30'/2mm(9mm/m) Технические характеристики: Ø43x27x13mm</p> <p>Item: MC-432713 Sensitivity: 30'/2mm(9mm/m) Specification: Ø43x27x13mm</p>
---	--

 <p>Код : MC-251513 Точность: 7'/2mm(2.1mm/m) Технические характеристики: Ø25x15x13mm</p> <p>Item: MC-251513 Sensitivity: 7'/2mm(2.1mm/m) Specification: Ø25x15x13mm</p>	 <p>Код : MC-201815 Точность: 10'/2mm(3mm/m) Технические характеристики: Ø20x18x15mm</p> <p>Item: MC-201815 Sensitivity: 10'/2mm(3mm/m) Specification: Ø20x18x15mm</p>
---	--

 <p>Код : MC-1506 Точность: 5'/2mm(1.5mm/m) Технические характеристики: Ø15x6mm</p> <p>Item: MC-1506 Sensitivity: 5'/2mm(1.5mm/m) Specification: Ø15x6mm</p>	 <p>Код : MC-181413 Точность: 20'/2mm(6mm/m) Технические характеристики: Ø18x13.5x12.5mm</p> <p>Item: MC-181413 Sensitivity: 20'/2mm(6mm/m) Specification: Ø18x13.5x12.5mm</p>
---	--

 <p>Код : MC-2114 Точность: 10'/2mm(3mm/m) Технические характеристики: Ø21x14mm</p> <p>Item: MC-2114 Sensitivity: 10'/2mm(3mm/m) Specification: Ø21x14mm</p>	 <p>Код : MC-1510 Точность: 15'/2mm(4.5mm/m) Технические характеристики: Ø15x10mm</p> <p>Item: MC-1510 Sensitivity: 15'/2mm(4.5mm/m) Specification: Ø15x10mm</p>
---	--

 <p>Код : MC-1507 Точность: 7'/2mm(2.1mm/m) Технические характеристики: Ø15x7mm</p> <p>Item: MC-1507 Sensitivity: 7'/2mm(2.1mm/m) Specification: Ø15x7mm</p>	 <p>Код : MC-24516 Точность: 20'/2mm(6mm/m) Технические характеристики: Ø24.5x16mm</p> <p>Item: MC-24516 Sensitivity: 20'/2mm(6mm/m) Specification: Ø24.5x16mm</p>
---	--

Metal spirit levels



Part NO.	D1 (mm)	D2 (mm)	H (mm)	Sensitivity(Arc minutes)
MC-554012	55	40	12	30'/2mm
MC-503415	50	34	15	30'/2mm
MC-322012	32	20	12	18'/2mm
MC-321515	32	15	15	5'/2mm
MC-302015	30	20	14.5	30'/2mm
MC-302011	30	20	11	30'/2mm
MC-301808	30	18	8	120'/2mm
MC-291911	29	19	11	30'/2mm
MC-261712	25.7	16.5	11.5	30'/2mm
MC-231513	23	15	13	5'/2mm
MC-211312	21	13.5	12	30'/2mm
Remark	Другие характеристики доступны для настройки			Other specifications are available to be customized



Part NO.	D1(mm)	D2(mm)	H(mm)	Sensitivity (Arc minutes)
MC-281785	28	17	8.5	8'/2mm
MC-281709	28	17	9	10'/2mm
MC-281710	28	17	9.5	10'/2mm
MC-281612	28	16	11.5	10'/2mm
MC-221485	22	14	8.5	5'/2mm
Remark	Другие характеристики доступны для настройки			Other specifications are available to be customized

Metal spirit levels

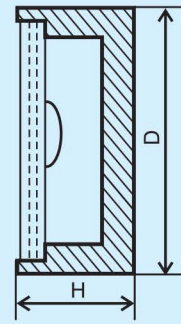
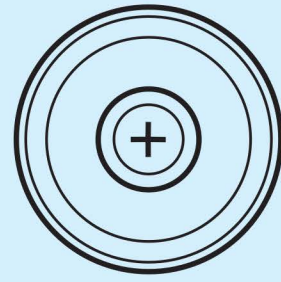

Part NO.	D (mm)	H (mm)	Sensitivity (Arc minutes)
MC60-1207	12	7	60'/2mm
MC30-1508	15	8	30'/2mm
MC60-1809	18	9	60'/2mm
MC90-1809B	18	9	90'/2mm
MC30-2608	26	8	35'/2mm
MC30-3513	35	13	30'/2mm
Remark	Другие характеристики доступны для настройки Other specifications are available to be customized		

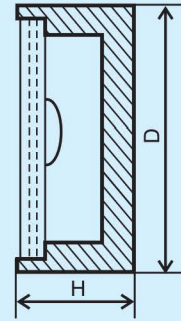
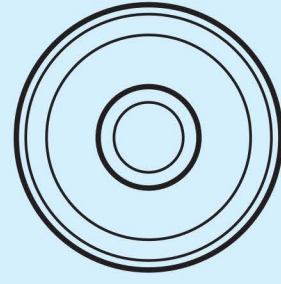

Part NO.	D(mm)	H (mm)	Sensitivity (Arc minutes)	Part NO.	D (mm)	H (mm)	Sensitivity (Arc minutes)
MC-0805	8	5	60'/2mm	MC-1506	15	6	30'/2mm
MC-1004	10	4	60'/2mm	MC-1565	15	6.5	15'/2mm
MC-1006	10	6	60'/2mm	MC-1508	15	8	5'/2mm
MC-1108	11	8	5'/2mm	MC-1808	18	8	40'/2mm
MC-1206	12	6	120'/2mm	MC-1809	18	9	30'/2mm
MC-1207	12	7	60'/2mm	MC-2006	20	6	30'/2mm
MC-1208	12	8	60'/2mm	MC-2509	25	9	30'/2mm
MC-1210	12	10	60'/2mm	MC-2608	26	8	10'/2mm
MC-1307	13	7	60'/2mm	MC-3008	30	8	30'/2mm
MC-1406	14	6	60'/2mm	MC-3010	30	10	30'/2mm
MC-1408	14	8	30'/2mm	MC-3013	30	13	30'/2mm
MC-14506	14.5	6	30'/2mm	MC-3212	32	12	30'/2mm
MC-14508	14.5	8	5'/2mm	MC-3513	35	13	30'/2mm
MC-14907	14.9	7	5'/2mm				
Remark	Другие характеристики доступны для настройки Other specifications are available to be customized						

Metal spirit levels

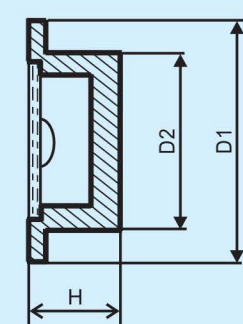
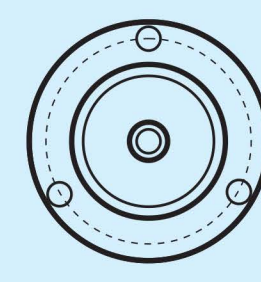

Part NO.	D1 (mm)	D2(mm)	H (mm)	Sensitivity (Arc minutes)
MC-312010	31	20	10	30'/2mm
MC-261864	26	18	6.4	30'/2mm
MC-251810	25	18	10	30'/2mm
MC-161408	16	14	8	20'/2mm
Remark	Другие характеристики доступны для настройки Other specifications are available to be customized			

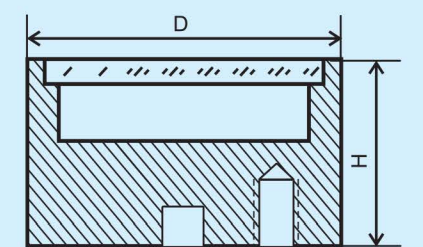
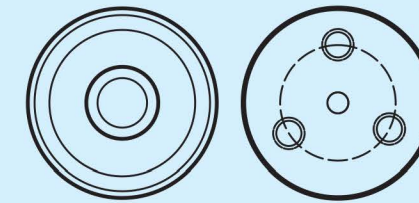

Part NO.	D(mm)	H(mm)	Sensitivity (Arc minutes)
MC-1510	15	10	10'/2mm
MC-18115	18	11.5	20'/2mm
MC-19115	19	11.5	30'/2mm
MC-20135	20	13.5	10'/2mm
Remark	Другие характеристики доступны для настройки Other specifications are available to be customized		

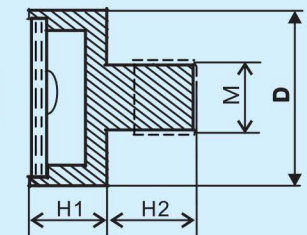
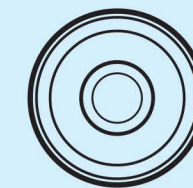

Part NO.	D(mm)	H1 (mm)	H2 (mm)	M (Thread)	Sensitivity (Arc minutes)
MC-2006B	20	6	5	M2.5	30'/2mm
MC-19510B	19.5	9.8	8.4	M6	30'/2mm
MC-1608B-1	16	8	8	M6	30'/2mm
MC-1608B-2	16	8	8	1/4"	30'/2mm
MC-1585B	15.1	8.5	3	M4	15'/2mm
MC-1508B	15	8	7	M6	10'/2mm
Remark	Другие характеристики доступны для настройки Other specifications are available to be customized				



Part NO.	D(mm)	H (mm)	Sensitivity (Arc minutes)
MC-6012DC	60	12	30"/2mm
MC-5010DC	50	10	30"/2mm
MC-4010DC	19	11.5	30"/2mm
MC-3513DC	35	13	30"/2mm
MC-3013DC	30	13	30"/2mm
MC-3010DC	30	10	30"/2mm
MC-2608DC	26	8	30"/2mm
MC-2509DC	25	9	30"/2mm
MC-2013DC	20	13	30"/2mm
MC-2006DC	20	6	30"/2mm
MC-1809DC	18	9	30"/2mm
MC1808DC	18	8	30"/2mm
MC-1508DC	15	8	30"/2mm
MC-14508DC	14.5	8	60"/2mm
MC-1307DC	13	7	60"/2mm
MC-1207DC	12	7	60"/2mm
MC-1206DC	12	6	120"/2mm
Remark	Другие характеристики доступны для настройки / Other specifications are available to be customized		

Двусторонний металлический пузырьковый уровень / Double Window Bubble Levels



Part NO.	D(mm)	H (mm)	Sensitivity(Arc minutes)
MC-3513T	35	13	30"/2mm
MC-3013T	30	13	30"/2mm
MC-3010T	30	10	30"/2mm
MC-2608T	26	8	30"/2mm
MC-2509T	25	9	30"/2mm
MC-2013T	20	13	30"/2mm
MC-1809T	18	9	60"/2mm
MC1808T	18	8	30"/2mm
MC-1508T	15	8	120"/2mm
MC-1206T	12	6	120"/2mm
Remark	Другие характеристики доступны для настройки / Other specifications are available to be customized		

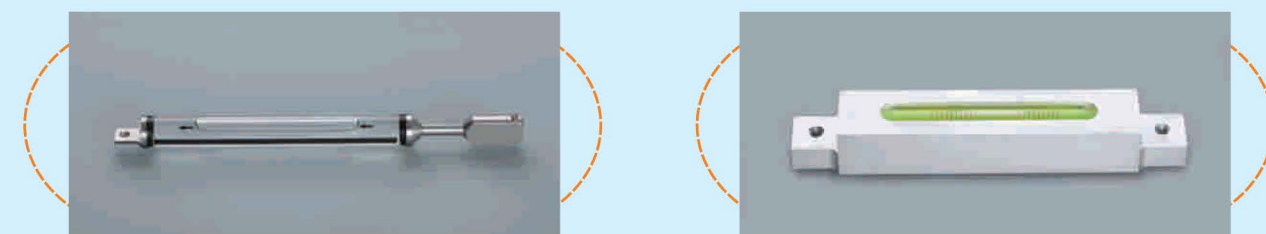

Кодировка : HD-N3	Item: HD-N3	Кодировка : HMT-1652723	Item: HMT-1652723
Точность : 10"/2mm(0.05mm/m)	Sensitivity: 10"/2mm(0.05mm/m)	Точность : 20"/2mm(0.10mm/m)	Sensitivity: 20"/2mm(0.10mm/m)
: Ø13x170mm	Specification: Ø13x170mm	Технические характеристики : 165x27x23mm	Specification: 165x27x23mm

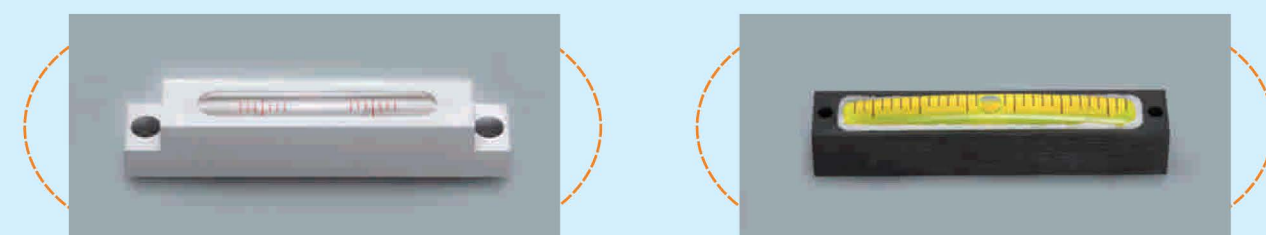

Кодировка : MT-1051919	Item: MT-1051919	Кодировка : MT-771412	Item: MT-771412
Точность : 4"/2mm(0.02mm/m)	Sensitivity: 4"/2mm(0.02mm/m)	Точность : 30"/2mm(9mm/m)	Sensitivity: 30"/2mm(9mm/m)
Технические характеристики : 105x19x19mm	Specification: 105x19x19mm	Технические характеристики : 77x14x12mm	Specification: 77x14x12mm

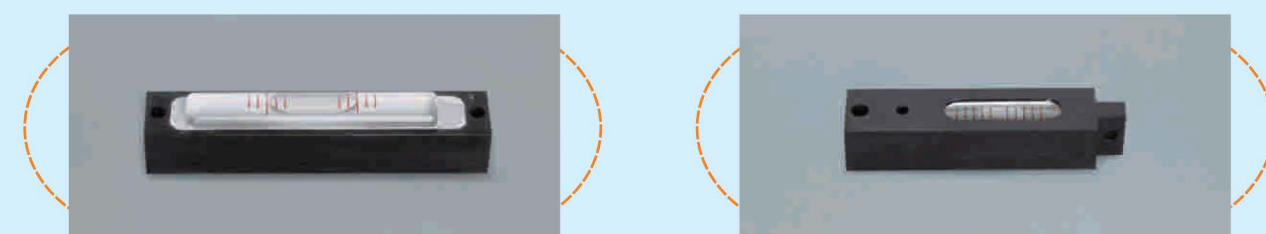

Кодировка : MT-771412B	Item: MT-771412B	Кодировка : MT-701512	Item: MT-701512
Точность : 20"/2mm(0.10mm/m)	Sensitivity: 20"/2mm(0.10mm/m)	Точность : 60"/2mm(0.30mm/m)	Sensitivity: 60"/2mm(0.30mm/m)
Технические характеристики : 77x14x12mm	Specification: 77x14x12mm	Технические характеристики : 70x15x12mm	Specification: 70x15x12mm

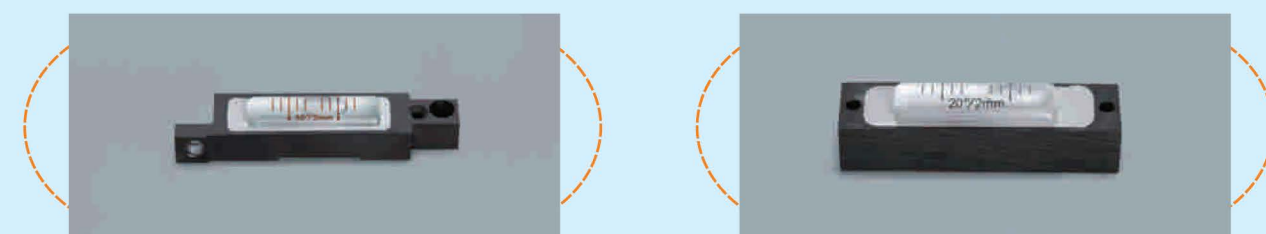

Кодировка : MT-701509	Item: MT-701509	Кодировка : MT-571412	Item: MT-571412
Точность : 30"/2mm(0.15mm/m)	Sensitivity: 30"/2mm(0.15mm/m)	Точность : 20"/2mm(0.10mm/m)	Sensitivity: 20"/2mm(0.10mm/m)
Технические характеристики : 70x15x9mm	Specification: 70x15x9mm	Технические характеристики : 58x14x12mm	Specification: 58x14x12mm



Кодировка: MCT-8018
 Технические характеристики: $\varnothing 80 \times 18 \text{mm}$
 Точность: 20" / 2mm(0.1mm/m)

Item: MCT-8018
 Spec: $\varnothing 80 \times 18 \text{mm}$
 Sensitivity: 20" / 2mm(0.1mm/m)

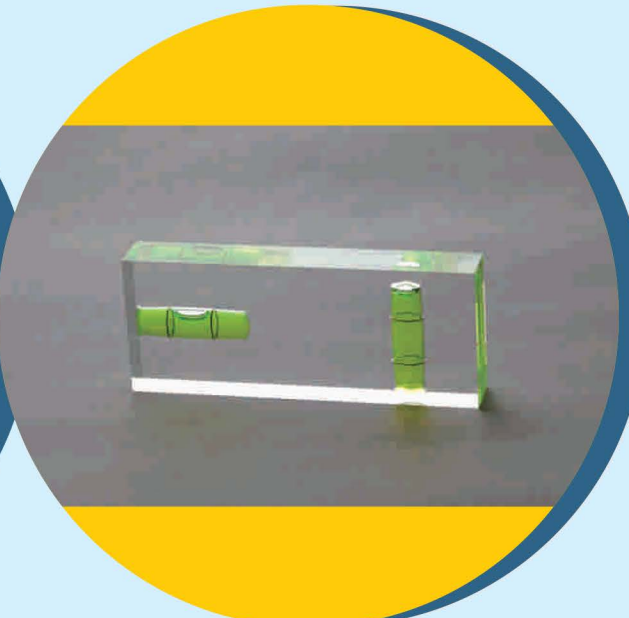

Кодировка: PSL-702516
 Технические характеристики: 70(L)x25(W)x16(T)
 Точность: 30' / 2mm(9mm/m)

Item: PSL-702516
 Spec: 70(L)x25(W)x16(T)
 Sensitivity: 30' / 2mm(9mm/m)



Кодировка: MSL-5844T
 Технические характеристики: 58x44mm
 Точность: 30' / 2mm(9mm/m)

Item: MSL-5844T
 Spec: 58x44mm
 Sensitivity: 30' / 2mm(9mm/m)



День
DAY

Кодировка: ILM-C90
 Технические характеристики: 90x70x21mm
 Точность: 30' / 2mm(9mm/m)
 Источник света: Светящийся порошок

Ночь
NIGHT

Item: ILM-C90
 Spec: 90x70x21mm
 Sensitivity: 30' / 2mm(9mm/m)
 Light source: Luminous powder



День
DAY

Кодировка: ILM-C70
 Технические характеристики: 70x21mm
 Точность: 30' / 2mm(9mm/m)
 Источник света: Светящийся порошок

Ночь
NIGHT

Item: ILM-C70
 Spec: 70x21mm
 Sensitivity: 30' / 2mm(9mm/m)
 Light source: Luminous powder



День
DAY

Кодировка: ILM-C26
 Технические характеристики: 26x16x14mm
 Точность: 10' / 2mm(3mm/m)
 Источник света: Светящийся порошок

Ночь
NIGHT

Item: ILM-C26
 Spec: 26x16x14mm
 Sensitivity: 10' / 2mm(3mm/m)
 Light source: Luminous powder



День
DAY

Кодировка: ILM-S120
 Технические характеристики: 120(L)x50(W)x15mm(T)
 Точность: 30' / 2mm(9mm/m)
 Источник света: Светящийся порошок

Ночь
NIGHT

Item: ILM-S120
 Spec: 120(L)x50(W)x15mm(T)
 Sensitivity: 30' / 2mm(9mm/m)
 Light source: Electricity

High precision glass level vials

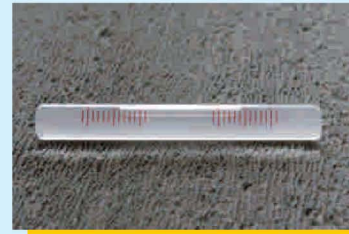

Кодировка: GTS02-14114
Точность: 2"/2mm(0.01mm/m)
Технические характеристики: Ø14x114mm
Item: GTS02-14114
Sensitivity: 2"/2mm(0.01mm/m)
Specification: Ø14x114mm

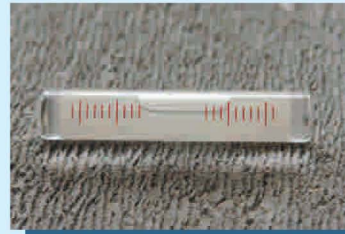

Кодировка: GTS04-1480
Точность: 4"/2mm(0.02mm/m)
Технические характеристики: Ø14x80mm
Item: GTS04-1480
Sensitivity: 4"/2mm(0.02mm/m)
Specification: Ø14x80mm



Кодировка: GTS04-1380
Точность: 4"/2mm(0.02mm/m)
Технические характеристики: Ø13x80mm
Item: GTS04-1380
Sensitivity: 4"/2mm(0.02mm/m)
Specification: Ø13x80mm

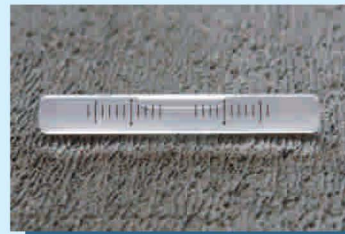

Кодировка: GTS10-1184
Точность: 10"/2mm(0.05mm/m)
Технические характеристики: Ø11x84mm
Item: GTS10-1184
Sensitivity: 10"/2mm(0.05mm/m)
Specification: Ø11x84mm



Кодировка: GTS20-1153
Точность: 20"/2mm(0.10mm/m)
Технические характеристики: Ø11x53mm
Item: GTS20-1153
Sensitivity: 20"/2mm(0.10mm/m)
Specification: Ø11x53mm

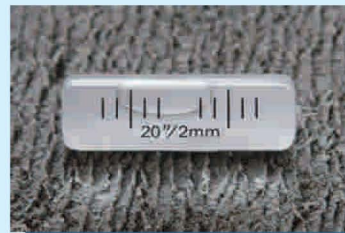

Кодировка: GTS20-1138
Точность: 20"/2mm(0.10mm/m)
Технические характеристики: Ø11x38mm
Item: GTS20-1138
Sensitivity: 20"/2mm(0.10mm/m)
Specification: Ø11x38mm



Кодировка: GTS20-1036
Точность: 20"/2mm(0.10mm/m)
Технические характеристики: Ø10.5x36mm
Item: GTS20-1036
Sensitivity: 20"/2mm(0.10mm/m)
Specification: Ø10.5x36mm



Кодировка: GTS20-1160
Точность: 20"/2mm(0.10mm/m)
Технические характеристики: Ø11x60mm
Item: GTS20-1160
Sensitivity: 20"/2mm(0.10mm/m)
Specification: Ø11x60mm

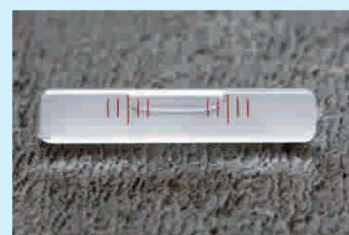

Кодировка: GTS20-1170
Точность: 20"/2mm(0.10mm/m)
Технические характеристики: Ø11x70mm
Item: GTS20-1170
Sensitivity: 20"/2mm(0.10mm/m)
Specification: Ø11x70mm

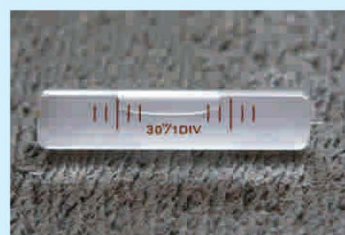

Кодировка: GTS30-1152
Точность: 30"/2mm(0.15mm/m)
Технические характеристики: Ø11x52mm
Item: GTS30-1152
Sensitivity: 30"/2mm(0.15mm/m)
Specification: Ø11x52mm

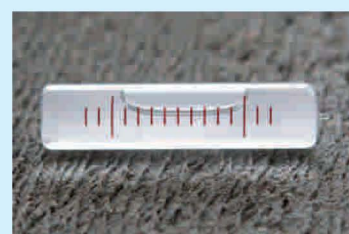

Кодировка: GTS30-1045
Точность: 30"/2mm(0.15mm/m)
Технические характеристики: Ø10x45mm
Item: GTS30-1045
Sensitivity: 30"/2mm(0.15mm/m)
Specification: Ø10x45mm



Кодировка: GTS30-0932
Точность: 30"/2mm(0.15mm/m)
Технические характеристики: Ø9x32mm
Item: GTS30-0932
Sensitivity: 30"/2mm(0.15mm/m)
Specification: Ø9x32mm



Кодировка: GTS30-1036
Точность: 30"/2mm(0.15mm/m)
Технические характеристики: Ø10.5x36mm
Item: GTS30-1036
Sensitivity: 30"/2mm(0.15mm/m)
Specification: Ø10.5x36mm



Кодировка: GTS30-1138A
Точность: 30"/2mm(0.15mm/m)
Технические характеристики: Ø11x38mm
Item: GTS30-11x38A
Sensitivity: 30"/2mm(0.15mm/m)
Specification: Ø11x38mm



Кодировка: GTS30-1138B
Точность: 30"/2mm(0.15mm/m)
Технические характеристики: Ø11x38mm
Item: GTS30-1138B
Sensitivity: 30"/2mm(0.15mm/m)
Specification: Ø11x38mm



Кодировка: GTS30-1154
Точность: 30"/2mm(0.15mm/m)
Технические характеристики: Ø11x54mm
Item: GTS30-1154
Sensitivity: 30"/2mm(0.15mm/m)
Specification: Ø11x54mm

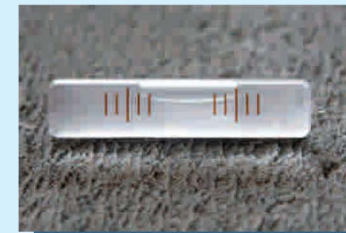

Кодировка: GTS30-1156
Точность: 30"/2mm(0.15mm/m)
Технические характеристики: Ø11x56mm
Item: GTS30-1156
Sensitivity: 30"/2mm(0.15mm/m)
Specification: Ø11x56mm



Кодировка: GTS40-1150
Точность: 40"/2mm(0.20mm/m)
Технические характеристики: Ø11x50mm
Item: GTS40-1150
Sensitivity: 40"/2mm(0.20mm/m)
Specification: Ø11x50mm



Кодировка: GTS40-1160
Точность: 40"/2mm(0.20mm/m)
Технические характеристики: Ø11x60mm
Item: GTS40-1160
Sensitivity: 40"/2mm(0.20mm/m)
Specification: Ø11x60mm

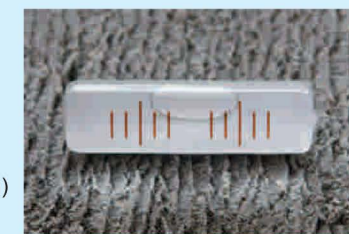

Кодировка: GTS45-1145
Точность: 45"/2mm(0.23mm/m)
Технические характеристики: Ø11x45mm
Item: GTS45-1145
Sensitivity: 45"/2mm(0.23mm/m)
Specification: Ø11x45mm

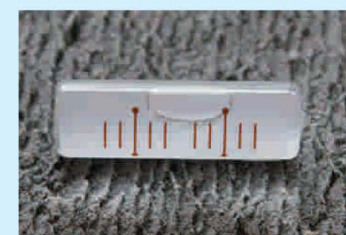

Кодировка: GTS60-1137
Точность: 60"/2mm(0.30mm/m)
Технические характеристики: Ø11x37mm
Item: GTS60-1137
Sensitivity: 60"/2mm(0.30mm/m)
Specification: Ø11x37mm



Кодировка: GTS60-1156
Точность: 60"/2mm(0.30mm/m)
Технические характеристики: Ø11x56mm
Item: GTS60-1156
Sensitivity: 60"/2mm(0.30mm/m)
Specification: Ø11x56mm



Кодировка: GTS60-1036
Точность: 60"/2mm(0.30mm/m)
Технические характеристики: Ø10.5x36mm
Item: GTS60-1036
Sensitivity: 60"/2mm(0.30mm/m)
Specification: Ø10.5x36mm

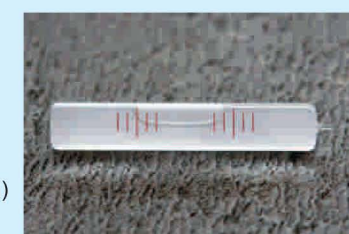

Кодировка: GTS90-1160
Точность: 90"/2mm(0.45mm/m)
Технические характеристики: Ø11x60mm
Item: GTS90-1160
Sensitivity: 90"/2mm(0.45mm/m)
Specification: Ø11x60mm

Precision glass level vials

Precision glass level vials



Кодировка: GTS90-1036
Точность: 90" /2mm
Технические характеристики: Ø10x36mm

Item: GTS90-1036
Sensitivity: 90" /2mm
Spec: Ø10x36mm

Кодировка: GTM03-1064
Точность: 3' /2mm
Технические характеристики: Ø10x64mm

Item: GTM03-1064
Sensitivity: 3' /2mm
Specification: Ø10x64mm



Кодировка: GTM04-0930W
Точность: 4' /2mm
Технические характеристики: Ø9x30mm

Item: GTM04-0930W
Sensitivity: 4' /2mm
Specification: Ø9x30mm

Кодировка: GTM08-0823
Точность: 8' /2mm
Технические характеристики: Ø8x23mm

Item: GTM08-0823
Sensitivity: 8' /2mm
Specification: Ø8x23mm



Кодировка: GTM03-0732
Точность: 3' /2mm
Технические характеристики: Ø7x32mm

Item: GTM03-0732
Sensitivity: 3' /2mm
Specification: Ø7x32mm

Кодировка: GTM02-0733
Точность: 2' /2mm
Технические характеристики: Ø7x33mm

Item: GTM02-0733
Sensitivity: 2' /2mm
Specification: Ø7x33mm

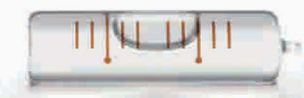
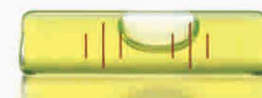

Кодировка: GTM02-0833
Точность: 2' /2mm
Технические характеристики: Ø8x33mm

Item: GTM02-0833
Sensitivity: 2' /2mm
Specification: Ø8x33mm

Кодировка: GTM02-1036
Точность: 2' /2mm
Технические характеристики: Ø10x36mm

Item: GTM02-1036
Sensitivity: 2' /2mm
Specification: Ø10x36mm



Кодировка: GTM03-1150
Точность: 3' /2mm
Технические характеристики: Ø11x50mm

Item: GTM03-1150
Sensitivity: 3' /2mm
Specification: Ø11x50mm

Кодировка: GTM04-0935
Точность: 4' /2mm
Технические характеристики: Ø9x35mm

Item: GTM04-0935
Sensitivity: 4' /2mm
Specification: Ø9x35mm



Кодировка: GTM06-0726
Точность: 6' /2mm
Технические характеристики: Ø7x26mm

Item: GTM06-0726
Sensitivity: 6' /2mm
Specification: Ø7x26mm

Кодировка: GTM02-0833
Точность: 2' /2mm
Технические характеристики: Ø8x33mm

Item: GTM02-0833
Sensitivity: 2' /2mm
Specification: Ø8x33mm



Кодировка: GTM04-0844
Точность: 4' /2mm
Технические характеристики: Ø8x44mm

Item: GTM04-0844
Sensitivity: 4' /2mm
Specification: Ø8x44mm

Кодировка: GTM08-0723
Точность: 8' /2mm
Технические характеристики: Ø7x23mm

Item: GTM08-0723
Sensitivity: 8' /2mm
Specification: Ø7x23mm



Кодировка: GTM04-1064
Точность: 4' /2mm
Технические характеристики: Ø10x64mm

Item: GTM04-1064
Sensitivity: 4' /2mm
Specification: Ø10x64mm

Кодировка: GTM02-1150
Точность: 2' /2mm
Технические характеристики: Ø11x50mm

Item: GTM02-1150
Sensitivity: 2' /2mm
Specification: Ø11x50mm



Кодировка: GTM06-0823
Точность: 6' /2mm
Технические характеристики: Ø8x23mm

Item: GTM06-0823
Sensitivity: 6' /2mm
Specification: Ø8x23mm

Кодировка: GTM02-12120
Точность: 2' /2mm
Технические характеристики: Ø12x120mm

Item: GTM02-12120
Sensitivity: 2' /2mm
Specification: Ø12x120mm



Кодировка: GTM04-0830W
Точность: 4' /2mm
Технические характеристики: Ø8x30mm

Item: GTM04-0830W
Sensitivity: 4' /2mm
Specification: Ø8x30mm

Кодировка: GTM04-0925W
Точность: 4' /2mm
Технические характеристики: Ø9x25mm

Item: GTM04-0925W
Sensitivity: 4' /2mm
Specification: Ø9x25mm

Bent glass level vials



Кодировка: GTB40-08148
Точность: 40'/2mm(12mm/m)
Технические характеристики: Ø8x148mm

Item: GTB40-08148
Sensitivity: 40'/2mm(12mm/m)
Specification: Ø8x148mm



Кодировка: GTB52-08110
Точность: 52'/2mm(16mm/m)
Технические характеристики: Ø8x110mm

Item: GTB52-08110
Sensitivity: 52'/2mm(16mm/m)
Specification: Ø8x110mm



Кодировка: GTB60-0890
Точность: 60'/2mm(18mm/m)
Технические характеристики: Ø8x90mm

Item: GTB60-0890
Sensitivity: 60'/2mm(18mm/m)
Specification: Ø8x90mm



Кодировка: GTB30-0863
Точность: 30'/2mm(9mm/m)
Технические характеристики: Ø8x63mm

Item: GTB30-0863
Sensitivity: 30'/2mm(9mm/m)
Specification: Ø8x63mm



Кодировка: GTB30-0770
Точность: 30'/2mm(9mm/m)
Технические характеристики: Ø7x70mm

Item: GTB30-0770
Sensitivity: 30'/2mm(9mm/m)
Specification: Ø7x70mm



Кодировка: GTB30-0864
Точность: 30'/2mm(9mm/m)
Технические характеристики: Ø8x64mm

Item: GTB30-0864
Sensitivity: 30'/2mm(9mm/m)
Specification: Ø8x64mm



Кодировка: GTB30-0776
Точность: 30'/2mm(9mm/m)
Технические характеристики: Ø7x76mm

Item: GTB30-0776
Sensitivity: 30'/2mm(9mm/m)
Specification: Ø7x76mm



Кодировка: GTB30-0765
Точность: 30'/2mm(9mm/m)
Технические характеристики: Ø7x65mm

Item: GTB30-0765
Sensitivity: 30'/2mm(9mm/m)
Specification: Ø7x65mm



Кодировка: GTB40-0860
Точность: 40'/2mm(12mm/m)
Технические характеристики: Ø8x60mm

Item: GTB40-0860
Sensitivity: 40'/2mm(12mm/m)
Specification: Ø8x60mm

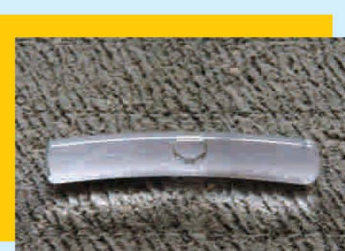

Кодировка: GTB60-0744
Точность: 60'/2mm(18mm/m)
Технические характеристики: Ø7x44mm

Item: GTB60-0744
Sensitivity: 60'/2mm(18mm/m)
Specification: Ø7x44mm



Кодировка: GTB30-0830
Точность: 30'/2mm(9mm/m)
Технические характеристики: Ø8x30mm

Item: GTB30-0830
Sensitivity: 30'/2mm(9mm/m)
Specification: Ø8x30mm



Кодировка: GTB30-0826
Точность: 30'/2mm(9mm/m)
Технические характеристики: Ø8x26mm

Item: GTB30-0826
Sensitivity: 30'/2mm(9mm/m)
Specification: Ø8x26mm

Bent glass level vials

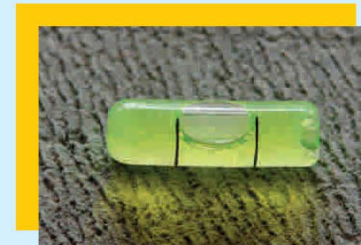

Кодировка: GTB30-0826W
Точность: 30'/2mm(9mm/m)
Технические характеристики: Ø8x26mm

Item: GTB30-0826W
Sensitivity: 30'/2mm(9mm/m)
Specification: Ø8x26mm

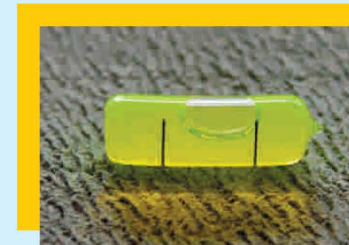

Кодировка: GTB40-0826
Точность: 40'/2mm(12mm/m)
Технические характеристики: Ø8x26mm

Item: GTB40-0826
Sensitivity: 40'/2mm(12mm/m)
Specification: Ø8x26mm



Кодировка: GTB30-0833
Точность: 30'/2mm(9mm/m)
Технические характеристики: Ø8x33mm

Item: GTB30-0833
Sensitivity: 30'/2mm(9mm/m)
Specification: Ø8x33mm



Кодировка: GTB30-0736
Точность: 30'/2mm(9mm/m)
Технические характеристики: Ø7x36mm

Item: GTB30-0736
Sensitivity: 30'/2mm(9mm/m)
Specification: Ø7x36mm



Кодировка: GTB50-0518
Точность: 50'/2mm(15mm/m)
Технические характеристики: Ø5x18mm

Item: GTB50-0518
Sensitivity: 50'/2mm(15mm/m)
Specification: Ø5x18mm



Кодировка: GTB30-0517
Точность: 30'/2mm(9mm/m)
Технические характеристики: Ø5x17mm

Item: GTB30-0517
Sensitivity: 30'/2mm(9mm/m)
Specification: Ø5x17mm



Кодировка: GTB30-0726
Точность: 30'/2mm(9mm/m)
Технические характеристики: Ø7x26mm

Item: GTB30-0726
Sensitivity: 30'/2mm(9mm/m)
Specification: Ø7x26mm



Кодировка: GTB60-0532
Точность: 60'/2mm(18mm/m)
Технические характеристики: Ø5x32mm

Item: GTB60-0532
Sensitivity: 60'/2mm(18mm/m)
Specification: Ø5x32mm



Glass circular spirit level bubbles



Кодировка: GCP60-4507
Точность: 60'/2mm(18mm/m)
Технические характеристики: Ø45x7mm

Item: GCP60-4507
Sensitivity: 60'/2mm(18mm/m)
Specification: Ø45x7mm

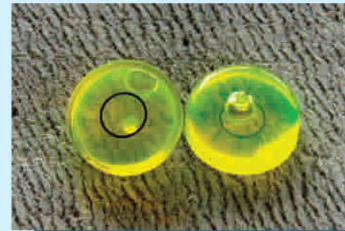

Кодировка: GC10-1810
Точность: 10'/2mm(3mm/m)
Технические характеристики: Ø18x10mm

Item: GC10-1810
Sensitivity: 10'/2mm(3mm/m)
Specification: Ø18x10mm



Кодировка: GC08-17510
Точность: 8'/2mm(2.4mm/m)
Технические характеристики: Ø17.5x10mm

Item: GC08-17510
Sensitivity: 8'/2mm(2.4mm/m)
Specification: Ø17.5x10mm



Кодировка: GC08-1108
Точность: 8'/2mm(2.4mm/m)
Технические характеристики: Ø11x8mm

Item: GC08-1108
Sensitivity: 8'/2mm(2.4mm/m)
Specification: Ø11x8mm



Кодировка: GC06-1810
Точность: 6'/2mm(1.8mm/m)
Технические характеристики: Ø18x10mm

Item: GC06-1810
Sensitivity: 6'/2mm(1.8mm/m)
Specification: Ø18x10mm



Кодировка: GC10-1685
Точность: 10'/2mm(3mm/m)
Технические характеристики: Ø16x8.5mm

Item: GC10-1685
Sensitivity: 10'/2mm(3mm/m)
Specification: Ø16x8.5mm

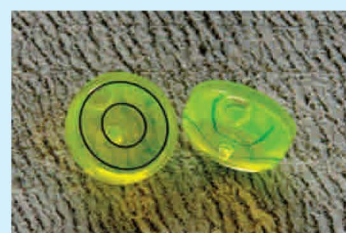

Кодировка: GC25-1510
Точность: 25'/2mm(7.5mm/m)
Технические характеристики: Ø15x10mm

Item: GC25-1510
Sensitivity: 25'/2mm(7.5mm/m)
Specification: Ø15x10mm



Кодировка: GC10-1409
Точность: 10'/2mm(3mm/m)
Технические характеристики: Ø14x09mm

Item: GC10-1409
Sensitivity: 10'/2mm(3mm/m)
Specification: Ø14x09mm



Кодировка: GC10-1510
Точность: 10'/2mm(3mm/m)
Технические характеристики: Ø15x10mm

Item: GC10-1510
Sensitivity: 10'/2mm(3mm/m)
Specification: Ø15x10mm



Кодировка: GC10-13310
Точность: 10'/2mm(3mm/m)
Технические характеристики: Ø13.3x10mm

Item: GC10-13310
Sensitivity: 10'/2mm(3mm/m)
Specification: Ø13.3x10mm



Кодировка: GC10-1458
Точность: 10'/2mm(3mm/m)
Технические характеристики: Ø14.5x8mm

Item: GC10-1458
Sensitivity: 10'/2mm(3mm/m)
Specification: Ø14.5x8mm



Кодировка: GC40-1510
Точность: 40'/2mm(12mm/m)
Технические характеристики: Ø15x10mm

Item: GC40-1510
Sensitivity: 40'/2mm(12mm/m)
Specification: Ø15x10mm

Glass circular spirit level bubbles



Кодировка: GC60-1610
Точность: 60'/2mm(18mm/m)
Технические характеристики: Ø16x10mm

Item: GC60-1610
Sensitivity: 60'/2mm(18mm/m)
Specification: Ø16x10mm



Кодировка: GC10-1610
Точность: 10'/2mm(3mm/m)
Технические характеристики: Ø16x10mm

Item: GC10-1610
Sensitivity: 10'/2mm(3mm/m)
Specification: Ø16x10mm



Кодировка: GC30-1208
Точность: 30'/2mm(9mm/m)
Технические характеристики: Ø12x8mm

Item: GC30-1208
Sensitivity: 30'/2mm(9mm/m)
Specification: Ø12x8mm

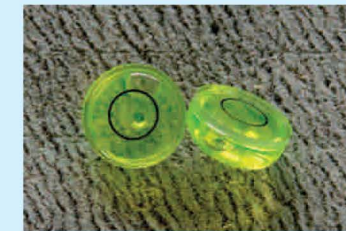

Кодировка: GC60-1309
Точность: 60'/2mm(18mm/m)
Технические характеристики: Ø13x9mm

Item: GC60-1309
Sensitivity: 60'/2mm(18mm/m)
Specification: Ø13x9mm



Кодировка: GC10-1308
Точность: 10'/2mm(3mm/m)
Технические характеристики: Ø13x8mm

Item: GC10-1308
Sensitivity: 10'/2mm(3mm/m)
Specification: Ø13x8mm



Кодировка: G10-1659
Точность: 10'/2mm(3mm/m)
Технические характеристики: Ø16.5x9mm

Item: G10-1659
Sensitivity: 10'/2mm(3mm/m)
Specification: Ø16.5x9mm



Кодировка: GC60-1008
Точность: 60'/2mm(18mm/m)
Технические характеристики: Ø10x8mm

Item: GC60-1008
Sensitivity: 60'/2mm(18mm/m)
Specification: Ø10x8mm



Кодировка: GCP05-1807
Точность: 5'/2mm(1.5mm/m)
Технические характеристики: Ø18x7mm

Item: GCP05-1807
Sensitivity: 5'/2mm(1.5mm/m)
Specification: Ø18x7mm



Кодировка: GCP25-1706
Точность: 25'/2mm(7.5mm/m)
Технические характеристики: Ø17x6mm

Item: GCP25-1706
Sensitivity: 25'/2mm(7.5mm/m)
Specification: Ø17x6mm



Кодировка: GCP10-1506
Точность: 10'/2mm(3mm/m)
Технические характеристики: Ø15x6mm

Item: GCP10-1506
Sensitivity: 10'/2mm(3mm/m)
Specification: Ø15x6mm



Кодировка: GCP15-1455
Точность: 15'/2mm(4.5mm/m)
Технические характеристики: Ø14x5.5mm

Item: GCP15-1455
Sensitivity: 15'/2mm(4.5mm/m)
Specification: Ø14x5.5mm



Кодировка: GCP15-1205
Точность: 15'/2mm(4.5mm/m)
Технические характеристики: Ø12x5mm

Item: GCP15-1205
Sensitivity: 15'/2mm(4.5mm/m)
Specification: Ø12x5mm

 <p>Кодировка: PC-433011 Технические характеристики: Ø43x30x11mm</p> <p>Item: PC-433011 Specification: Ø43x30x11mm</p>	 <p>Кодировка: PC-6010 Технические характеристики: Ø60x10mm</p> <p>Item: PC-6010 Specification: Ø60x10mm</p>
---	--

 <p>Кодировка: PC-3212 Технические характеристики: Ø32x12mm</p> <p>Item: PC-3212 Specification: Ø32x12mm</p>	 <p>Кодировка: PC-2505 Технические характеристики: Ø25x5mm</p> <p>Item: PC-2505 Specification: Ø25x5mm</p>
---	---

 <p>Кодировка: PC-211710 Технические характеристики: Ø21x17x10mm</p> <p>Item: PC-211710 Specification: Ø21x17x10mm</p>	 <p>Кодировка: PC-201610 Технические характеристики: Ø20x16x10mm</p> <p>Item: PC-201610 Specification: Ø20x16x10mm</p>
--	--

 <p>Кодировка: PC-191711B Технические характеристики: Ø19.4x16.6x11.4mm</p> <p>Item: PC-191711B Specification: Ø19.4x16.6x11.4mm</p>	 <p>Кодировка: PC-1508T Технические характеристики: Ø14.8x8mm</p> <p>Item: PC-1508T Specification: Ø14.8x8mm</p>
---	---

 <p>Кодировка: PC-503217 Технические характеристики: Ø 49.2x31.5x17mm</p> <p>Item: PC-503217 Specification: Ø 49.2x31.5x17mm</p>	 <p>Кодировка: PC-554011 Технические характеристики: Ø55X40X11mm</p> <p>Item: PC-554011 Specification: Ø55X40X11mm</p>
---	--

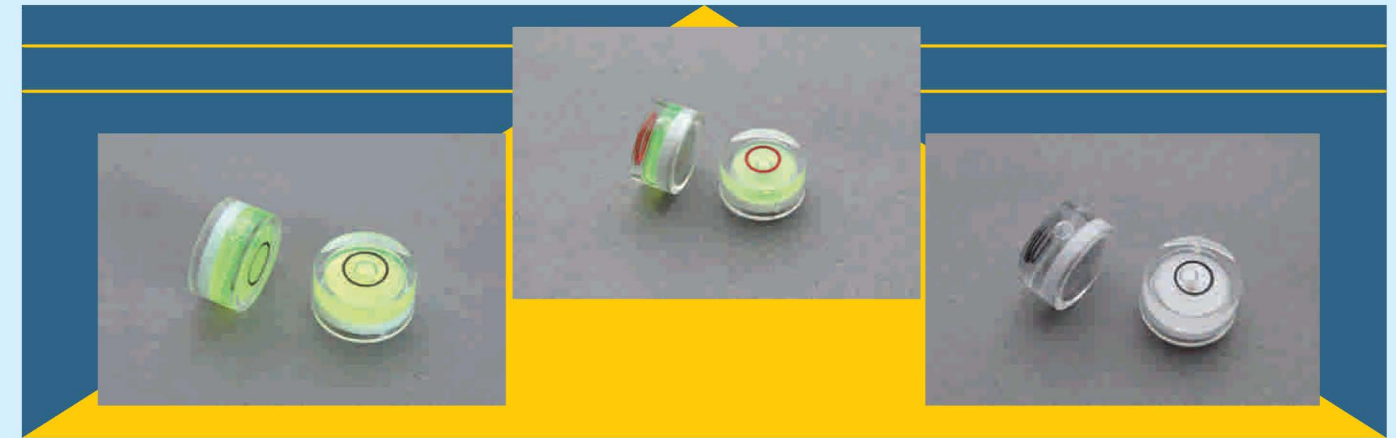

Part NO.	Diameter (mm)	Height (mm)
PC-0805	8	5.5
PC-1006	10	6
PC-1007	10	7
PC-1106	11	6
PC-1185	11	8.5
PC-1206	12	6
PC-1207	12	7
PC-1275	12	7.5
PC-1307	13	7
PC-1408	14	8
PC-1506	15	6
PC-1508	15	8
PC-1608	16	8
PC-1809	18	9
PC-2005	20	5.5
PC-2505	25	5.5
PC-2510	25	10
PC-2516	25	16
PC-3010	30	10
PC-3207	32	7
PC-3212	32	12
PC-3514	35	14
PC-6010	60	10
Remark	Другие характеристики доступны для настройки Other specifications are available to be customized	

Plastic tubular spirit level vials

Special bubble levels



Кодировка: PT-1641
Технические характеристики: Ø16x41mm

Item: PT-1641
Specification: Ø16x41mm



Кодировка: PT-1145
Технические характеристики: Ø11x45mm

Item: PT-1145
Specification: Ø11x45mm



Кодировка: PT-9540
Технические характеристики: Ø9.5x40mm

Item: PT-9540
Specification: Ø9.5x40mm

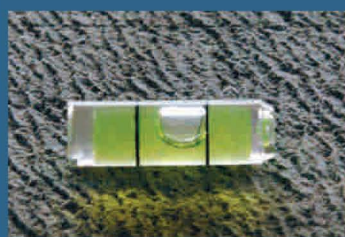

Кодировка: PT-6721
Технические характеристики: Ø6.7x21mm

Item: PT-6721
Specification: Ø6.7x21mm



Кодировка: PT-0822
Технические характеристики: Ø8x22.5mm

Item: PT-0822
Specification: Ø8x22.5mm



Кодировка: PT-0615
Технические характеристики: Ø6x15mm

Item: PT-0615
Specification: Ø6x15mm

ITEM NO	DIAMETER	LENGTH
PT-0512	5	12
PT-0614	6	13.7
PT-0615	6	15
PT-0620	6	20
PT-6329	6.3	29
PT-6519	6.5	18.5
PT-6526	6.5	25.5
PT-6527	6.5	26.5
PT-0716	7	16
PT-0718	7	18
PT-0726	7	26
PT-0819	8	19.4
PT-0820	8	20
PT-0822	8	22.3
PT-0823	8	23

ITEM NO	DIAMETER	LENGTH
PT-0825	8	25
PT-0831	8	31
PT-0835	8	34.5
PT-9525	9.5	25
PT-9532	9.5	31.8
PT-9534	9.5	34
PT-9540	9.5	40
PT-1023	10	23
PT-1025	10	25
PT-1030	10	30
PT-1035	10	35
PT-1040	10	40
PT-1145	11	45
PT-1240	12	40
PT-1641	16	41



Кодировка: SPS-401515
Технические характеристики: 40x15x15mm

Item: SPS-401515
Specification: 40x15x15mm



Кодировка: SPS-401515B
Технические характеристики: 40x15x15mm

Item: SPS-401515B
Specification: 40x15x15mm



Кодировка: SPS-401515C
Технические характеристики: 40x15x15mm

Item: SPS-401515C
Specification: 40x15x15mm



Кодировка: SPS-401517
Технические характеристики: 40x15.2x16.9mm

Item: SPS-401517
Specification: 40x15.2x16.9mm



Кодировка: SPS-291010
Технические характеристики: 29x10x10mm

Item: SPS-291010
Specification: 29x10x10mm



Кодировка: SPS-551515B
Технические характеристики: 55x15x15mm

Item: SPS-551515
Specification: 55x15x15mm



Кодировка: SPS-551515
Технические характеристики: 55x15x15mm

Item: SPS-551515
Specification: 55x15x15mm



Кодировка: SPS-332214
Технические характеристики: 33x22x14mm

Item: SPS-332214
Specification: 33x22x14mm



Кодировка: SPS-3516
Технические характеристики: Ø35.1x16.3mm

Item: SPS-3516
Specification: Ø35.1x16.3mm



Кодировка: SPS-3415
Технические характеристики: Ø34x15mm

Item: SPS-3415
Specification: Ø34x15mm



Кодировка: SPS-2813
Технические характеристики: Ø28x13mm
Item: SPS-2813
Specification: Ø28x13mm

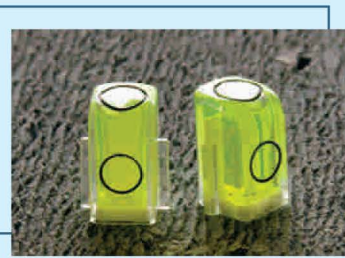

Кодировка: SPS-121423
Технические характеристики: 12x14x23mm
Item: SPS-121423
Specification: 12x14x23mm



Кодировка: SPS-690615
Технические характеристики: 68x6.5x14.5mm
Item: SPS-690615
Specification: 68x6.5x14.5mm

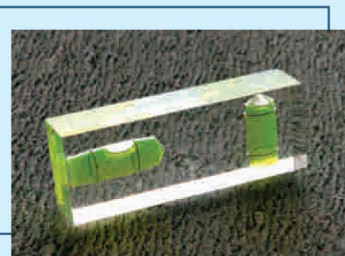

Кодировка: PSL-702516
Технические характеристики: 70x25.5x16mm
Item: PSL-702516
Specification: 70x25.5x16mm



Кодировка: MSL-5844T
Технические характеристики: 58x44mm
Item: MSL-5844T
Specification: 58x44mm



Кодировка: MSL-482813
Технические характеристики: 48x27.6x12.5mm
Item: MSL-482813
Specification: 48x27.6x12.5mm



Кодировка: MSL-592513
Технические характеристики: 59x25x13mm
Item: MSL-592513
Specification: 59x25x13mm



Кодировка: SPS-381808
Технические характеристики: 38x18x8mm
Item: SPS-381808
Specification: 38x18x8mm



Кодировка: PSL-322495
Технические характеристики: 32x24x9.5mm
Item: PSL-322495
Specification: 32x24x9.5mm



Кодировка: PSL-300907
Технические характеристики: 30x9x7mm
Item: PSL-300907
Specification: 30x9x7mm



Кодировка: MSL-02X
Технические характеристики: 74x13x19.5mm
Item: MSL-02X
Specification: 74x13x19.5mm



Кодировка: MSL-01X
Технические характеристики: 77x15x26mm
Item: MSL-01X
Specification: 77x15x26mm



Кодировка: MSL-03X
Технические характеристики: 76x13x22mm
Item: MSL-03X
Specification: 76x13x22mm



Кодировка: PSL-1251510P
Технические характеристики: 125x15x10.5mm
Item: PSL-1251510P
Specification: 125x15x10.5mm



Кодировка: PSL-1002046
Технические характеристики: 100x20x46mm
Item: PSL-1002046
Specification: 100x20x46mm



Кодировка: CSL-02C
Технические характеристики: 140X90mm
Item: CSL-02C
Specification: 140X90mm



Кодировка: CSL-01C
Технические характеристики: 135X105mm
Item: CSL-01C
Specification: 135X105mm



Кодировка: TSL-04T
Технические характеристики: 230mm
Item: TSL-04T
Specification: 230mm



Кодировка: TSL-03T
Технические характеристики: 230mm
Item: TSL-03T
Specification: 230mm



Кодировка: TSL-07T
Технические характеристики: 210mm
Item: TSL-07T
Specification: 210mm



Кодировка: TSL-02T
Технические характеристики: 225mm
Item: TSL-02T
Specification: 225mm



Кодировка: TSL-06T
Технические характеристики: 230mm
Item: TSL-06T
Specification: 230mm



Кодировка: TSL-01T
Технические характеристики: 200mm
Item: TSL-01T
Specification: 200mm



Кодировка: TSL-05T
Технические характеристики: 235mm
Item: TSL-05T
Specification: 235mm